

APRIL 1976

# HEWLETT-PACKARD JOURNAL



# Electronic Total Station Speeds Survey Operations

*This new electronic surveying instrument measures slope distance and zenith angle simultaneously, then computes and displays horizontal or vertical distance in feet or metres. Its base measures horizontal angle.*

by **Michael L. Bullock** and **Richard E. Warren**

**I**N 1970, WITH THE INTRODUCTION of the 3800A Distance Meter, Hewlett-Packard launched into the electronic measurement of distance. Since that time HP has become a major supplier of electronic distance measuring equipment (EDM). Typically, EDM has been used in conjunction with some angle measuring device such as a transit, because the position of one point with respect to another is usually described by a horizontal distance, a vertical distance, and a horizontal angle from a known bearing or line. Now both distance and angle measuring capability are available in a new instrument—the 3810A Total Station (Fig. 1).

In the past, horizontal distance was measured by taping the distance, being very careful to maintain the tape in a horizontal plane, or by measuring the slope distance (typically with EDM equipment), measuring the zenith angle (using a theodolite or transit), and then computing the horizontal distance on a calculator. The 3810A Total Station is capable of measuring slope distance and zenith angle simultaneously and then calculating the horizontal distance or vertical distance for immediate display. This horizontal distance capability, combined with a base that measures horizontal angle, makes the total station a powerful instrument for subdivision layout, as well as for many other surveying applications (see page 6).

A glance at the total station's control panel (Fig. 2) shows not only its simplicity of operation but also the variety of measurement options selectable by the operator. The total station measures and displays either vertical, horizontal, or slope distance, or zenith angle. It gives a single reading to the full resolution of the instrument or continuously updated readings with reduced resolution. Readings are in feet or metres for distances and degrees/minutes/seconds or grads for angle. The operator simply preselects the desired function and units, aims the instrument at the target

point using the integral telescope and aiming tangent screws, and presses the MEASURE button. The instrument then automatically controls its own measurement cycle to produce the desired readout. All parameters other than the selected one are also measured or computed and are available for immediate recall. The continuously updated reading is especially useful for such things as laying out a certain distance.

The total station measures distances up to 1.6 km (1 mile) with resolution as fine as 1 mm. Measurements are accurate within 5 mm + 10 ppm.

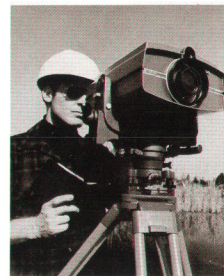

**Cover:** *With its built-in calculator, angle transducer, and modulated-light-beam distance measuring system, this one instrument, Model 3810A Total Station, gives the operator a direct readout of distance to a pole-mounted retroreflector held by his rod man. The displayed horizontal distance, corrected for refraction and the earth's curvature, is automatically derived from slope distance and vertical angle.*

## **In this Issue:**

*Electronic Total Station Speeds Survey Operations, by Michael L. Bullock and Richard E. Warren . . . . .* **page 2**

*Designing Efficiency into a Digital Processor for an Analytical Instrument, by John S. Poole and Len Bilen . . . .* **page 13**

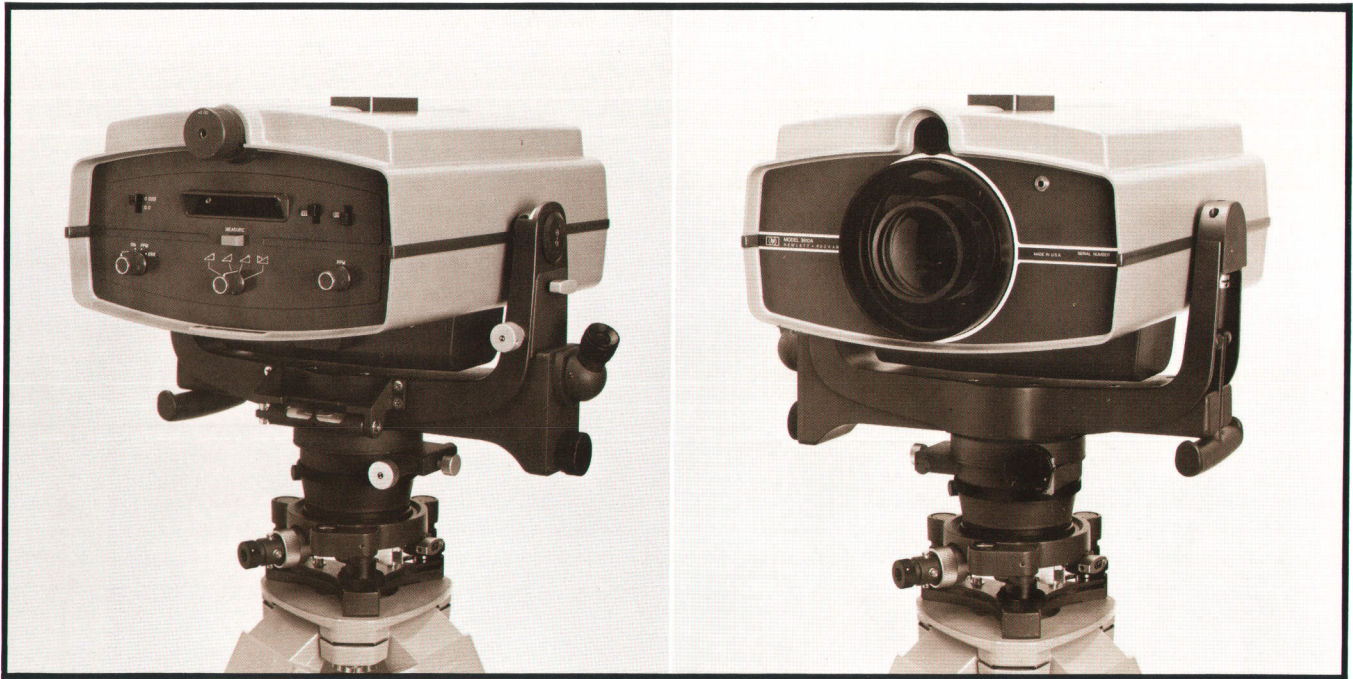

**Fig. 1.** Model 3810A Total Station measures horizontal, vertical, and slope distances and vertical angle, all automatically. Its calibrated base measures horizontal angle. A snap-in battery pod eliminates cables.

### Distance Measuring Technology

The total station measures distance using amplitude modulation of a light beam (910 nm wavelength) from a GaAs diode. The wavelength of the modulation envelope ( $\lambda_m$ ) is chosen to be consistent with the requirements of the measurement.

The modulated light is transmitted through a transmitter optics assembly and downrange to the end of

the line being measured, where a retroreflector sends the beam back to the instrument. A receiver optics assembly focuses the beam on a photodiode detector/mixer, which produces an electrical signal that has the characteristics of the received modulated light envelope. Ideally this signal is identical to the modulation signal except for a displacement or phase shift proportional to the measured line length.

The phase shift between the transmitted and received signals is a consequence of the finite velocity of the signal envelope, which is essentially equal to the speed of light. Fig. 3 shows how this phase shift is proportional to the distance being measured. The light beam actually travels the measured distance twice, once going out and once coming back, and Fig. 3 shows the light path “unfolded” to illustrate more clearly the effect of distance on phase. A measured distance of  $\frac{1}{2}\lambda_m$  is equivalent to one complete modulation wavelength, or  $360^\circ$  of phase shift. Typically, a phase measurement cannot distinguish between  $0^\circ$  and  $360^\circ$  of phase shift, thus leading to a repetitive phase-versus-distance characteristic, as shown in Fig. 4. In the total station, two different modulating frequencies are used alternately, a lower frequency to determine the basic range, and a higher frequency for resolution. The frequencies are approximately 75 kHz, which provides a 2000-m measurement interval, and 15 MHz, which provides a 10-m interval.

In this idealized amplitude modulation system, the output signal of the detector is compared with the

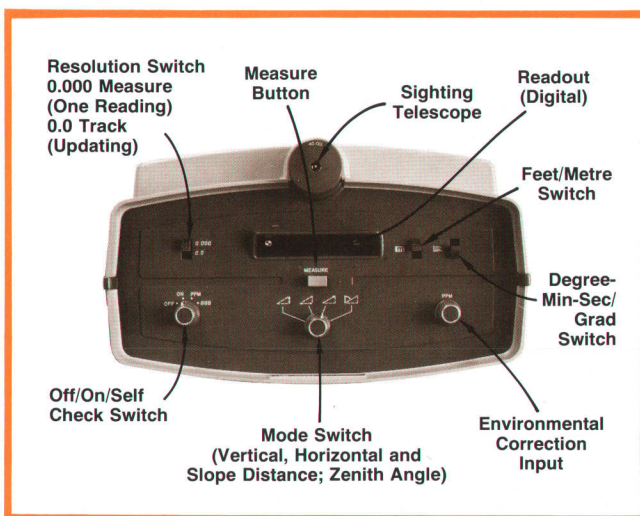

**Fig. 2.** 3810A control panel. Operator simply selects the function and units, aims the instrument at the target point using the integral telescope, and presses the MEASURE button. He can also select a single reading with full resolution or a continuously updated readout with reduced resolution.

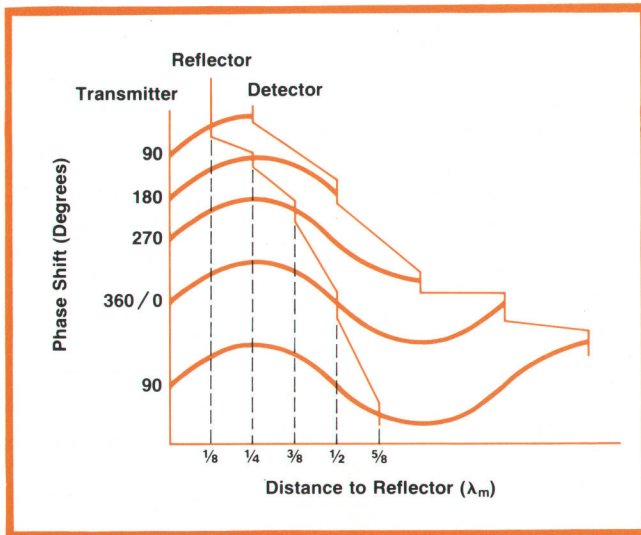

**Fig. 3.** The total station measures distance by measuring the phase shift between the modulation envelopes of two light beams. One is a reference light beam and the other is a light beam that has traversed the unknown distance and been reflected back to the instrument.

signal driving the modulator to determine phase shift. In practice, modulators and detectors introduce phase shift. If this phase shift were constant, it could be taken into account in the measurement. However, it can vary considerably with time and temperature and can therefore introduce measurement errors.

Our solution to this problem is to generate a reference signal that has been exposed to the same variable phase shifts (except that proportional to the distance being measured) as the transmitted-received signal. This is accomplished by alternately directing the output of the amplitude modulator to the transmitter optics and through an internal reference path to the detector. This guarantees that any phase shift introduced by the modulator and detector is present in both the external signal and the internal reference, so any differential phase shift between these two signals is proportional to the distance being measured.

#### Distance Measuring Circuits

A block diagram of the distance measurement portion of the 3810A Total Station is shown in Fig. 5. The basic resolution and accuracy are determined by the accuracy and stability of the 15-MHz oscillator in the transmitter, and these are determined by the temperature and time stability of the oscillator crystal. Typical long-term stability of the crystal is 2-3 ppm/year. The temperature coefficient of the oscillator is  $< \pm 10$  ppm over the entire environmental range of the instrument ( $-20^{\circ}\text{C}$  to  $+55^{\circ}\text{C}$ ).

The transmitter provides the drive signal to the emitting diode. It divides the 15-MHz signal digitally to provide the second modulation frequency of 75

kHz and a 3.75-kHz square wave electrical reference signal. The transmitter also provides 15-MHz and 75-kHz signals to the receiver.

The transmitter diode produces a modulated light beam under the control of the transmitter drive signal. The chopper, a blade rotating at a 10-Hz rate, alternately routes the diode output either through the transmitter optics (external path) or through the variable optical attenuator (internal path). The block labeled "optics" sends the light beam toward the target reflector and focuses the returned and reference beams on the detector diode.

The receiver and phase-lock circuit provides the local oscillator drive to the photodiode detector. The local oscillator drive is always 3.75 kHz above the modulation frequency currently being transmitted. The receiver has automatic gain control to maintain a constant output level regardless of input level. It also filters the detector output to eliminate all but the 3.75-kHz component.

The limiter takes the 3.75-kHz sine wave (IF) and produces a square wave output (IFL). The limiter is also an important part of the automatic balance feature of the 3810A. Under control of the microprocessor, the limiter detects the difference between the internal path signal amplitude and the external path signal amplitude, and adjusts this difference to zero by adjusting the variable attenuator in the internal path. When the two paths are balanced this fact is communicated back to the microprocessor via the flag line. Control lines from the phase detector tell the limiter when a reading is being taken and enable the beam break circuit on the limiter. The beam break circuit detects whether the IF signal is below or above preset levels. Data collected under such conditions is questionable, so the microprocessor eliminates it from the measurement process.

The phase detector and accumulator circuit makes the actual distance measurement by measuring the phase difference between the IFL signal and the 3.75-kHz reference. The internal path is measured

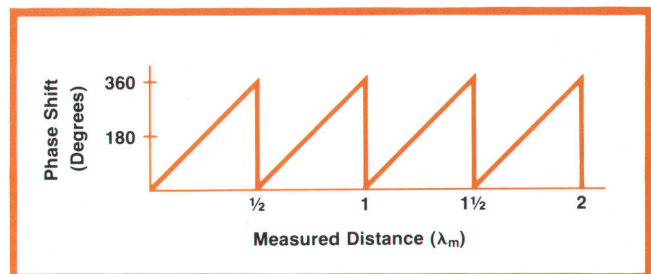

**Fig. 4.** Phase shift is a linear function of distance within one-half wavelength of the light-beam modulation signal. Two modulation frequencies are used: 75 kHz for the basic 2000-m measurement interval and 15 MHz for a 10-m interval and better resolution.

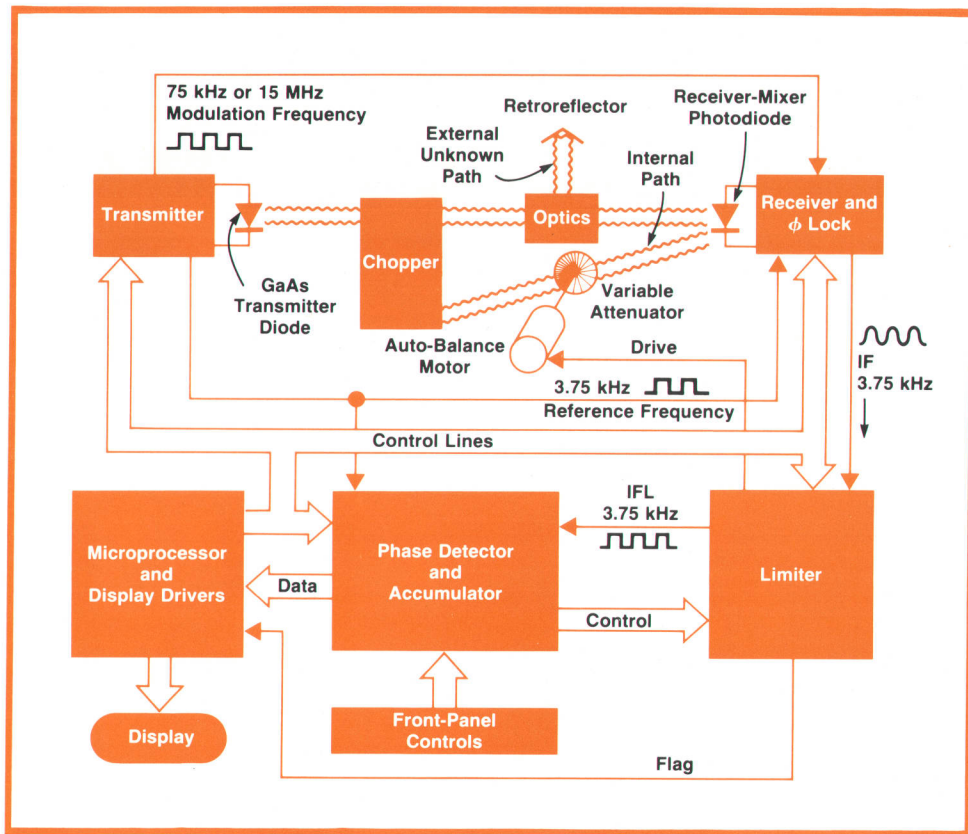

**Fig. 5.** Total station distance measuring circuits. Light at a wavelength of 910 nm is produced by a GaAs diode. The accumulator counts 15-MHz pulses for 100 cycles of the 3.75-kHz reference, first for the internal path and then for the external path; it then holds the average over 100 cycles of the phase difference between internal and external paths. This is transferred to the microprocessor for analysis and display.

first. The phase difference between IFL and the 3.75-kHz reference is determined by opening a gate on the leading edge of the 3.75-kHz reference signal and closing it on the leading edge of the IFL signal. While the gate is open, 15-MHz pulses enter the accumulator and count it upward. This is repeated for 100 cycles of the 3.75-kHz reference. At the end of 100 cycles the accumulator holds a number that represents the average phase difference between the 3.75-kHz reference and the IFL signal (internal path) over those 100 cycles. Next, the external path signal is selected, and a similar measurement is done, except that the accumulator is counted down. The accumulator then holds the average over 100 cycles of the phase difference between internal and external paths. Measured data is then transferred to the microprocessor for analysis and display.

### Angle Measuring Technology

Fig. 6 is a block diagram of the angle measuring system of the 3810A Total Station. The system is divided into two sections, analog and digital. The analog section does the actual angle measurement, while the digital section controls the timing of the measurement and interfaces the angle system to the rest of the instrument.

The operation of the analog section is serial in nature. The 2.5-kHz oscillator is the source of the drive signal that is used to make the angle measurement.

The active attenuator divides this signal by a factor of almost 20, and the transducer driver provides an inverted version of this signal to the angle transducer.

Because of the precision needed in the angle measurement, the effects of electronic noise must be kept to a very low level. This is done by starting out with an oscillator that has a good output signal-to-noise ratio. Noise components in the output of the transducer driver are more than one million times smaller than the desired signal.

The transducer is the heart of the angle system. Details of its construction are discussed in the box on page 10. Electrically, the transducer can be represented by the circuit shown in Fig. 7. Two of the "resistors",  $R_L$  and  $R_R$ , are functions of tilt angle  $\theta$  and another parameter  $*$ , while  $R_A$  is a function only of  $*$ . The parameter  $*$  includes the effects of geometry, physical properties, temperature, and other parameters. The transducer sense amplifier senses tilt angle as shown in Fig. 8. Notice that the effects of the non-angle-related parameters are cancelled, leaving only a function of tilt angle  $\theta$  and some constant factors that are calibrated out.

In the conversion from ac to dc, differences can creep into the various signal paths and cause errors. For this reason the next three blocks in Fig. 6 are tied together in an automatic zeroing loop. The signal select block, under control of the digital section timing signals, connects the rectifier block to one of three pos-

## How the Total Station Is Used

The primary application for the 3810A Total Station is layout. A typical layout application might be a subdivision of 40 acres divided into 160 individual lots. The drawing of this subdivision (Fig. 1) has all the points located by horizontal distances and horizontal angles from other points. With a 3810A and the drawing, the points can easily be set out with almost no field calculations or iterations, since the total station displays horizontal distance directly. If the crew has transposed these rectangular coordinates into polar coordinates about control points, then even faster layout can be accomplished because the instrument can be set up at only a few locations and all other points laid out from there. In laying out a point, the continuously updated reading becomes very useful, helping the operator tell the rod man when he is close to the desired spot. Then the instrument is switched to make an accurate reading and the final few centimetres can be set with a pocket tape.

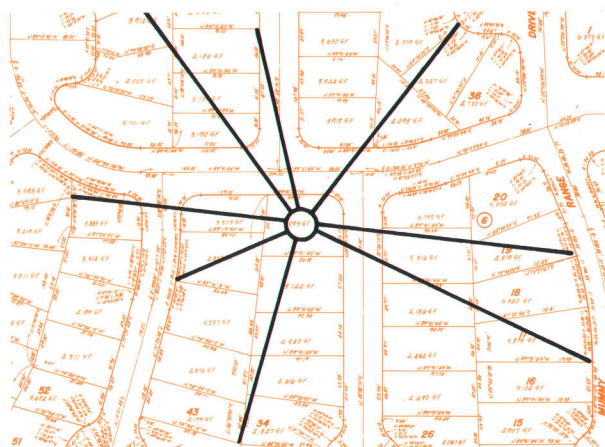
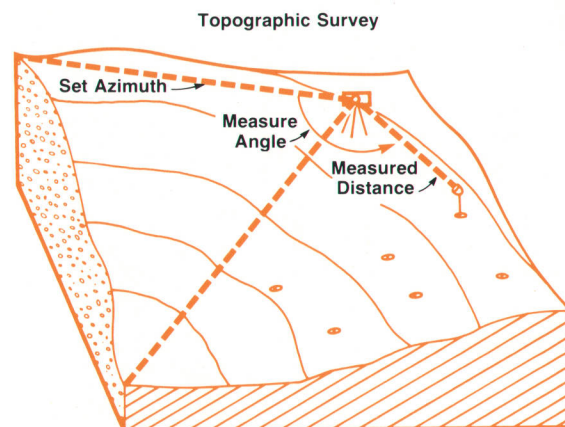

**Fig. 1.** Typical subdivision layout. Horizontal distances and angles are important measurements.

In laying out along a line, there is still the problem of getting the rod man on line. To speed up this step, an accessory called a line finder can be mounted on top of the total station. This is an optical device that tells the rod man whether he is to the right or the left of the line by showing him different colors when he looks back at the instrument. With a total station and the techniques

described here, time savings of 30-60% over other methods are easily obtained in layout situations.

Another type of application that the total station does well is detail and location survey. Since the instrument has both distance and angle capability, a survey for topographic information can be done with this one instrument (Fig. 2). By setting the target on the range pole at the same height as the instrument, differences in elevation can be read directly. The horizontal location of each point can also be established using horizontal distance and horizontal angle.



**Fig. 2.** Topographic survey is another application for which the 3810A Total Station is well suited.

An application apart from land surveying is in the hydrographic area, for example plotting a profile of a river or lake bottom. The total station can quickly determine the position of a boat that is equipped with sounding equipment to measure depth. The resulting data can be correlated later to obtain a profile. Again, the updated reading is especially useful in this application.

The versatility of the total station should also help it meet the requirements of many other applications, such as building foundation layout, utility and/or pipeline layout, traverse surveys, volume estimating, and general highway layout.

sible voltages. The rectifier provides full-wave rectification of its input signal in synchronism with the 2.5-kHz  $V_{Ref}$  signal. The active low-pass filter converts the full-wave rectified signal to a dc level for use in the A-to-D converter. During the autozero portion of an angle measurement the signal select block grounds the input to the rectifier and causes the resulting system offset voltages to be stored on a capacitor so their effect can be subtracted from the integrator input voltage.

During a measurement the output of the active low-pass filter is a dc level alternately proportional to the reference voltage or to the unknown angle-dependent voltage. The dual-slope integrator operates on these two voltage levels. It "ramps up" on the unknown

voltage for a fixed time, then "ramps down" on the known reference voltage until the ramp crosses through zero. The ramp-down time is proportional to the unknown angle. This time is measured in the digital section by counting pulses while ramp-down is in progress.

The digital section provides all the timing signals for angle measurement and accumulates the actual angle measurement. The digital section is controlled by an ASM (algorithmic state machine). The qualifier multiplexer allows various signals to affect the value of the state counter only when they are intended to do so. The state counter keeps track of which phase of the measurement is currently taking place. The state counter decoding logic generates the control signals

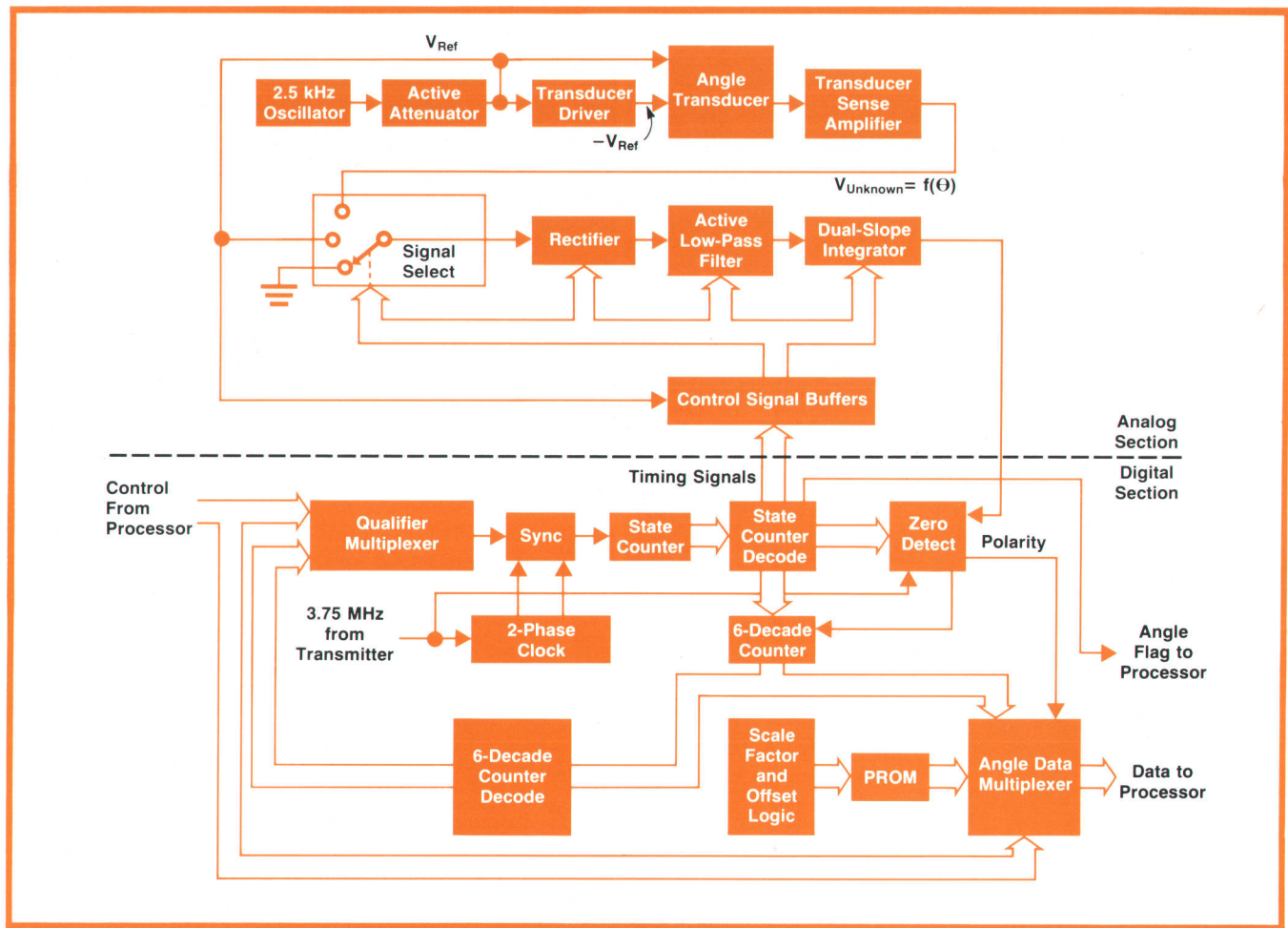

**Fig. 6.** Total station zenith-angle measuring circuits. The analog section excites the angle transducer and converts its output to a dc level that is measured by the dual-slope integration technique. The digital section provides timing and control.

needed to operate the analog section and to control the six-decade counter. The six-decade counter generates the timing for auto-zero and ramp-up operations and serves as the reading accumulator during ramp-down. The zero-detect logic senses when the ramp crosses through zero, thus terminating the accumulation of ramp-down counts. The scale factor and offset logic generates signals under processor control to

allow readout of the PROM that calibrates the angle system. The angle data multiplexer routes the various data sources to the processor for combination and display. The angle system controls itself during a reading cycle, thereby freeing the microprocessor to control other instrument functions while an angle reading is being taken.

### Processor Technology

The 3810A Total Station uses the same microprocessor as the HP-35 hand-held calculator.<sup>1</sup> The microprocessor provides not only calculating ability but also complicated control functions that would be practically impossible by any other technique. Fig. 9 shows the processor system and its interfaces to the rest of the instrument.

The microprocessor determines when an angle measurement is called for and, at the proper time, signals the angle logic sequencer to proceed. The microprocessor continues with its calculations until the angle flag signal goes high, at which time four data

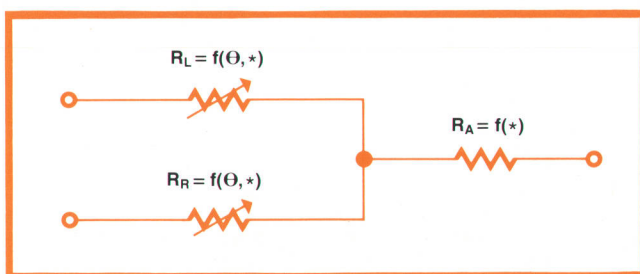

**Fig. 7.** Angle transducer equivalent circuit.  $\theta$  is the unknown angle and  $*$  is a parameter that includes the effects of geometry, physical properties, temperature, and other factors.

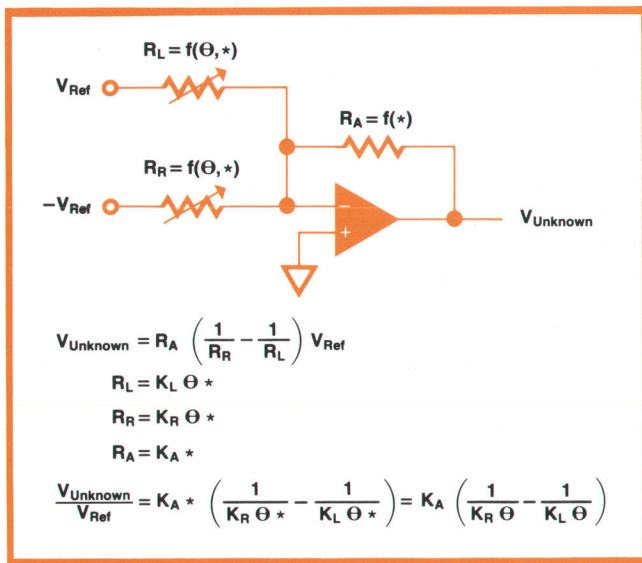

**Fig. 8.** The transducer sense amplifier cancels the effects of non-angle-related parameters, leaving only a function of tilt angle  $\theta$  and some constant factors that are calibrated out.

strobe lines are properly sequenced to read out the data from the angle system via the data bus. The microprocessor corrects for angle scale factor and offset as follows:

$$\text{Corrected angle} = (\text{raw angle} \times \text{scale factor}) + \text{offset}$$

All of the angle system readings are in decimal degrees referenced to level. The microprocessor converts the units to either degrees-minutes-seconds or to grads and changes the reference from level to zenith.

The distance measuring system interface exemplifies the deeper levels of control the microprocessor

exerts upon the system. Fig. 10 shows this interface in greater detail.

Most of the interface between the distance measuring system and the microprocessor consists of the phase detector interface, since the phase detector is the last link in the distance measuring system. The control lines to the phase detector control block determine when a reading is initiated, select initial phase detector operating mode, and modify the operating mode to account for existing conditions as shown by the initial readings.

The phase detector flag signals the processor when a phase detector cycle is completed. A typical distance measurement consists of many such phase detector cycles. At the end of each cycle the processor examines the good flag line to determine if a beam break condition existed any time during the last phase detector cycle. If a beam break did occur the processor ignores the data taken during that cycle and initiates a new phase detector cycle.

In addition to controlling the phase detector to measure distance, the processor can switch the phase detector input to the output of a one-shot delay circuit. The delay is controlled by the position of a variable resistor located on the front panel of the instrument. The processor requests that the phase detector measure the phase corresponding to this delay, and displays the phase as a number between +110 and -40. This reading is taken repetitively; it allows the operator to dial in a parts-per-million correction factor to be applied to the distance measurement. The correction factor, a function of air temperature and pressure, is necessary to compensate for changes in the velocity of light caused by changes in the index of refraction of air.

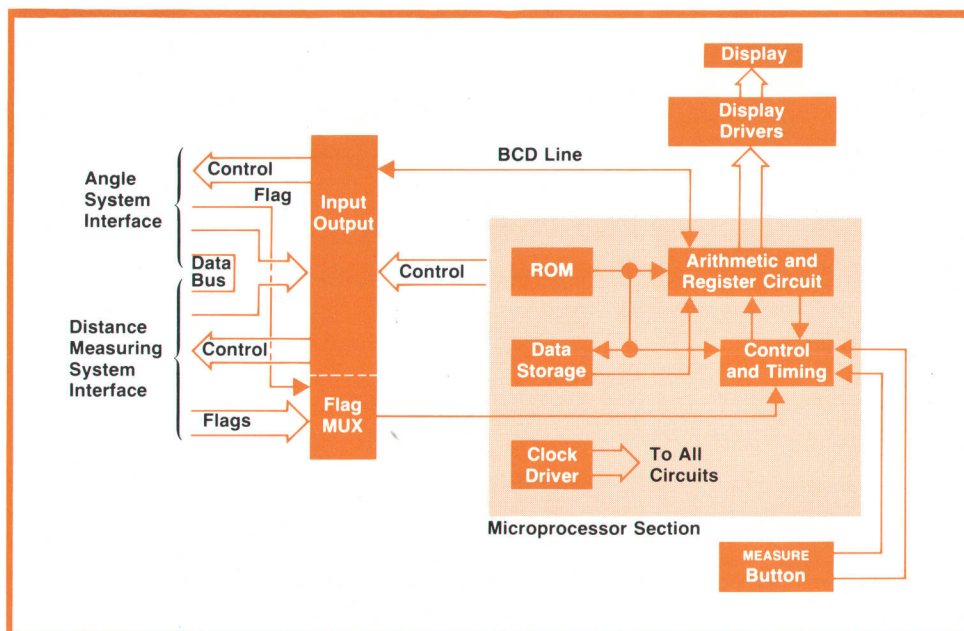

**Fig. 9.** The microprocessor provides sophisticated control and computational capabilities. This simplified diagram shows the microprocessor and its interfaces to the angle and distance circuits.



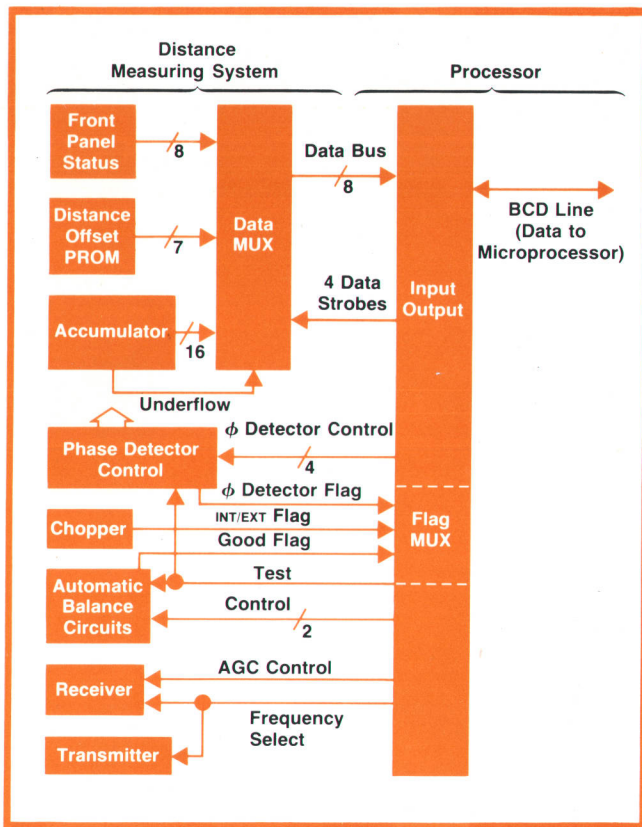

Fig. 10. A more detailed look at the interface between the microprocessor and the distance measuring circuits. In a distance measurement the processor handles all control and computation functions, including statistical analysis of the raw data to detect marginal measuring conditions.

The lines labeled “four data strobes” in Fig. 10 control the data multiplexer, which in turn routes data from several sources onto the data bus for entry into the microprocessor. Data basically comes from three sources: phase measured data comes from the accumulator, distance offset information is read from a programmable PROM structure, and front-panel status information is read from the front-panel controls.

The microprocessor also performs other control functions in the distance measuring system. The operation of the automatic balance circuit is controlled by two lines. The time during which the receiver AGC is allowed to track deviations in received signal amplitude is controlled by the AGC sample/hold line. The selection of which modulation frequency, either 15 MHz or 75 kHz, is being transmitted is controlled by the frequency select line. The test line indicates to the system that the operator has requested a self-test.

The processor performs many calculations in the course of each reading. Statistical analysis of the raw distance data is performed to determine if the variance,  $\sigma^2$ , lies within predetermined limits based

upon the instrument specification. If the variance exceeds these limits more data is taken until the variance is within limits or a maximum number of data samples has been taken. If this maximum number has been reached and the variance still exceeds the limits the average of these data samples is displayed in a flashing manner to warn the operator that the measuring conditions were marginal.

The processor also applies the dialed-in ppm correction factor, performs offset calibration, corrects the raw angle data for scale factor and offset, and calculates horizontal and vertical distances corrected for refraction and earth curvature. The equations used in this last calculation are:

$$H.D. = S.D. \cos \theta' \left[ 1 - \frac{S.D. \sin \theta'}{2R_E} \right]$$

$$V.D. = S.D. \sin \theta'$$

where H.D. is horizontal distance displayed, V.D. is vertical distance displayed, S.D. is slope distance measured,  $R_E$  is the radius of the earth, and  $\theta'$  is corrected vertical angle:

$$\theta' = \theta + 13.9 \text{ arc-seconds per } 1000 \text{ metres of slope distance.}$$

Finally, the processor does unit conversions to provide distances in metres or feet and angles in degrees-minutes-seconds, grads, or percent grade.

#### Front-Panel Self-Test

When the operator selects the -888 position on the front panel the processor lights all segments of the display to show that all are working. This results in a -8888.888 display. When the operator presses the MEASURE button with the switch in the -888 position the processor commands 20 different internal tests. If all tests are completed successfully, -8888.888 is displayed to indicate that the instrument is electronically sound with a high degree of confidence. If any test fails the instrument flashes “0” to indicate a problem. Self-test is very valuable for checking out an instrument before it is carried out into the field for use, an operation that may involve a crew of two or three persons traveling considerable distance. The test is not a 100% test, so it does not give 100% confidence, but it does test all functions that can be tested internally.

There are also thirteen additional test modes that are accessible only at the factory or service center. These tests help the service technician to determine the source of a problem and to verify proper operation when a repair has been made. For example, the front-panel self-test can also be accessed from a test key-

## Angle Transducer

In principle, the angle transducer is a very simple device. Basically, it is a resistive component with electrodes separated by an electrolyte (see Fig. 1). The electrode areas covered by electrolyte represent the angle to which the unit is tilted. If the right and left electrodes are covered equally, then the unit has zero output. As the unit is tilted, one side gets covered less while the other is covered more.

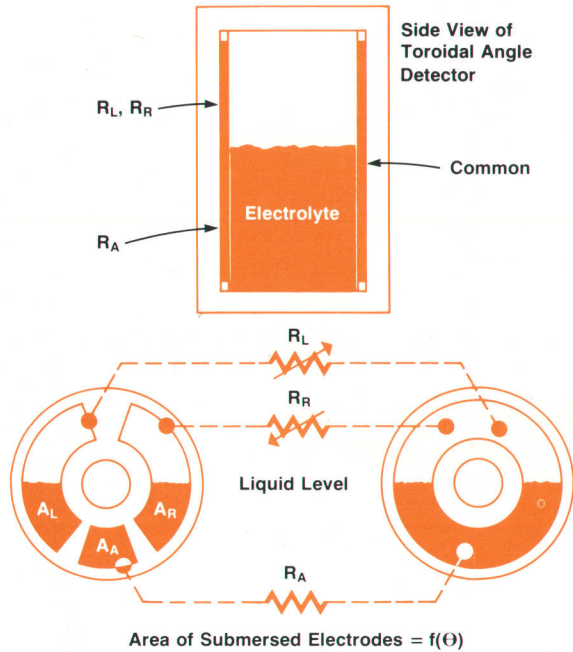

**Fig. 1.** 3810A angle transducer is a resistive component with electrodes covered by an electrolyte. Relative coverage of the two electrodes is a measure of tilt angle.

Although the concept is simple, there are many subtleties that require control in the fabrication of the parts and in their assembly to obtain an accurate device. The materials used have to be very stable with time and temperature. Machining and masking tolerances are most critical. The assembly must be completely sealed as well as void of any impurities. Finally, the assembly must be packaged in a manner that minimizes temperature gradients across the liquid. Integrated circuit technology is employed in manufacturing the electrodes, and a very stable ceramic material is used as the substrate. The parts are

fritted together and a glass tube is welded shut to finish the sealing after the device is filled. Two sets of thermal shields are added and the resulting device is a very reliable and accurate gravity sensing angle transducer. Gravity sensing is desirable because it means that only one sensor is needed to measure the

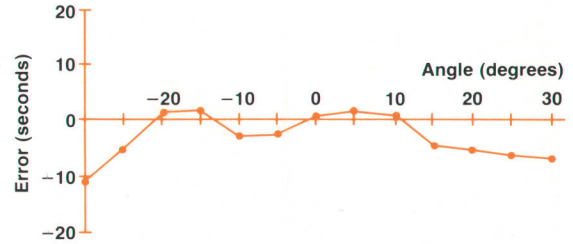

**Fig. 2.** Typical linearity error of vertical angle transducer

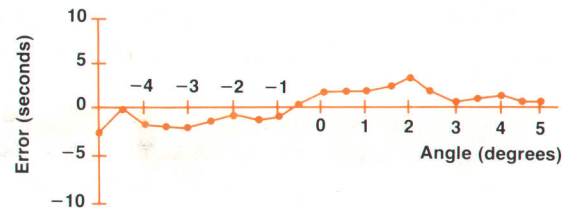

**Fig. 3.** Typical linearity error for small angles

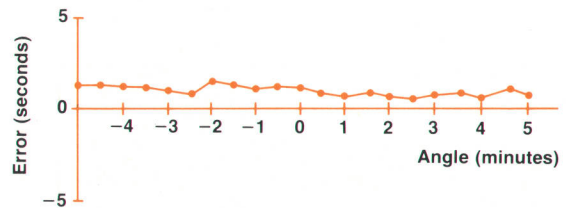

**Fig. 4.** Typical microlinearity of angle transducer

vertical angle and reference it to gravity. The sensor is sensitive only to the direction of gravity, not to its magnitude.

The accuracy of the angle transducer is shown in Figs. 2, 3, and 4. Fig. 2 shows a typical linearity error plot over the entire working range of  $\pm 30^\circ$ . Figs. 3 and 4 show the same type of errors at reduced ranges.

board. The identical tests are performed, but when a failure occurs the display shows a flashing code from 1 to 20 instead of a flashing "0". The service technician can then consult a table that describes the test that is failing, and the type of failure can be found using other available tests. The service tests also allow display of all raw distance and angle parameters in all combinations of operating mode, allow direct readout of calibration constants, test all processor controls by operating them in continuous

"signal generator" modes, provide known test conditions for checking auto-balance operations, and provide dynamic testing of flag return signals on a continuous basis. These added test modes mean easier, faster, and less costly production and repair.

### Optical System

The infrared lens system of the 3810A Total Station is one of the key elements in obtaining the range and accuracy of the distance meter portion of the

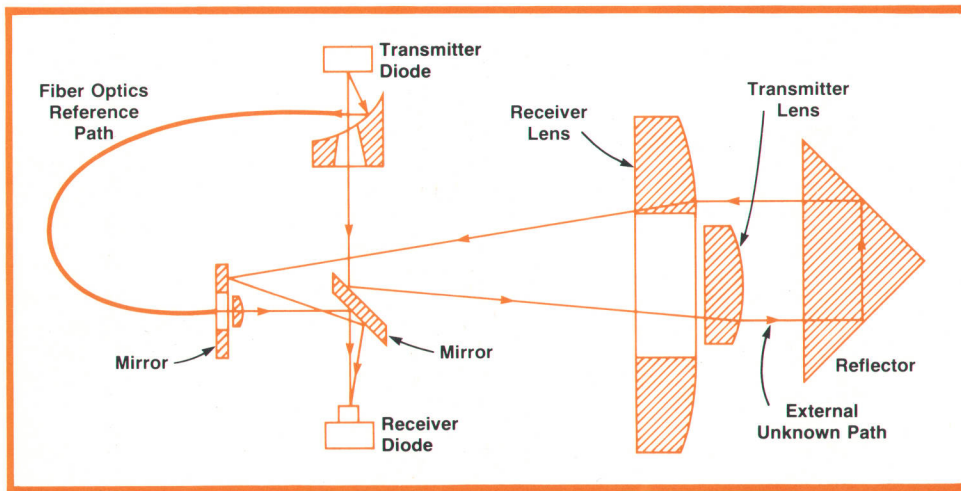

**Fig. 11.** Total station optical system produces a beam angle of 3 arc-minutes. Alignment of transmitter and receiver diodes is carefully done to assure accuracy of  $\pm(5 \text{ mm} + 10 \text{ ppm})$ .

instrument. A schematic view of the infrared optical system is shown in Fig. 11. The aperture of the lens system was designed to obtain the desired range. The focal lengths of the lenses and the sizes of the transmitter and receiver diodes are optimized to obtain the desired beam angle of 3 arc-minutes. Since only one wavelength is used (910 nm), color correction is not necessary. Spherical aberrations are corrected by using plano-convex doublet lenses.

Proper diode alignment and stability of this alignment are essential for obtaining and maintaining range and accuracy. Alignment is done by viewing the diodes with the same wavelength of light that is

transmitted and aligning the two diodes optically to the reticle of the telescope within  $12.5 \mu\text{m}$ . Stability is assured by lens, mirror, and diode mounting techniques. Thermal matching and/or thermal compensation by selection of materials is used in as many locations as possible. The surfaces that mount the optical elements are manufactured to precise tolerances so as not to distort the optical surfaces.

#### Horizontal Base and Telescope

The horizontal angle base of the 3810A Total Station is designed according to conventional practices used in modern theodolites. Horizontal angle is measured by accurately scribed lines on a glass circle. The operator uses a microscope and optical micrometer to observe the lines and interpolate between them while the circle is rotated about an accurate bearing/shaft arrangement.

The horizontal base, custom built for the total station, has a least count of 20 seconds with estimation to 5 seconds of arc (Fig. 12). This means that each minor division accounts for 20 seconds of arc but between these divisions interpolation to 5 seconds of arc is possible. The bearing/shaft design is cylindrical. Maximum radial clearance is approximately  $0.6 \mu\text{m}$ . Support is provided by ball bearing thrust members. Upper and lower halves of the base both move, allowing the operator to obtain more resolution by measuring the angle a number of times and dividing the sum of the readings by the number of readings.

To measure angle accurately one must be able to sight the object in question. The total station employs an  $18\times$  erect-image telescope for acquiring targets. Much design effort went into making this telescope stable and accurate, because the ability to measure angle is only as good as the sighting telescope. To assure stability, each assembly is thermally cycled ten times between  $-40^\circ$  and  $+160^\circ \text{ F}$ . Accuracy is obtained by close control of the machining and as-

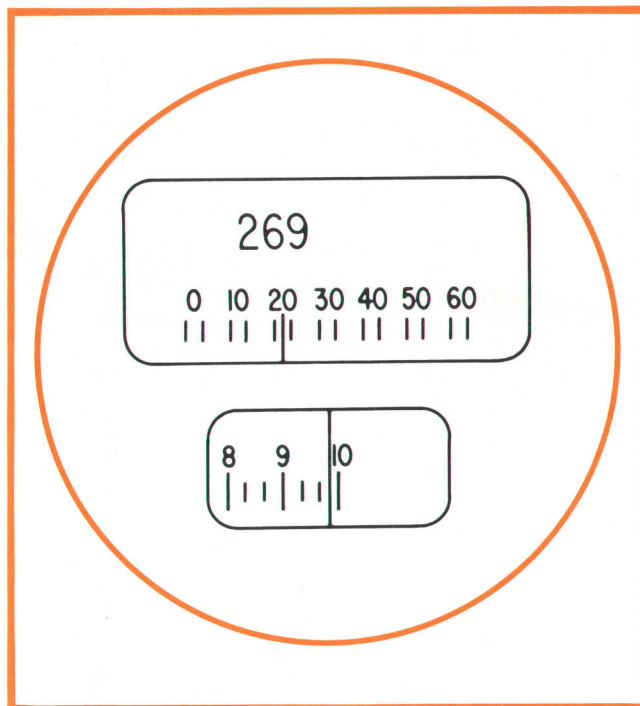

**Fig. 12.** Horizontal base has a least count of 20 seconds with estimation to five seconds of arc. The reading here is  $269^\circ 29' 50''$ .

## SPECIFICATIONS

### HP Model 3810A Total Station

**RANGE:** One mile (1.6 km) with a triple prism assembly under average conditions. Average conditions are those found during the day when moderate heat shimmer is evident.

**ACCURACY: Slope Distance**

$\pm (0.16 \text{ ft} + .01 \text{ ft per } 1000 \text{ ft}) \text{ m.s.e. @ } +15^\circ\text{F to } +105^\circ\text{F}$   
 $\pm (5 \text{ mm} + .10 \text{ mm per km}) \text{ m.s.e. @ } -10^\circ\text{C to } +40^\circ\text{C}$   
 $\pm (0.30 \text{ ft} + .03 \text{ ft per } 1000 \text{ ft}) \text{ m.s.e. @ } -5^\circ\text{F to } +15^\circ\text{F and } +105^\circ\text{F to } +130^\circ\text{F}$   
 $\pm (10 \text{ mm} + .30 \text{ mm per km}) \text{ m.s.e. @ } -20^\circ\text{C to } -10^\circ\text{C and } +40^\circ\text{C to } +55^\circ\text{C}$

**ACCURACY: Zenith Angle**

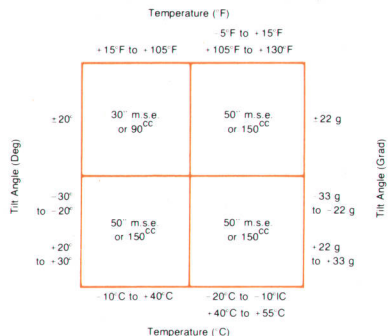

**PRECISION RATIOS FOR HORIZONTAL DISTANCE:** The precision ratio of the horizontal distance is dependent on the angular and slope distance accuracy of the HP 3810A Total Station. For any combination of slope distance and vertical angle to the right of Curve I, the precision ratio of the horizontal distance will be 1/10,000 or better. To the right of Curve II, the precision ratio will be 1/15,000 and to the right of curves III and IV, the precision ratio will be 1/25,000 or 1/50,000 or better, respectively.

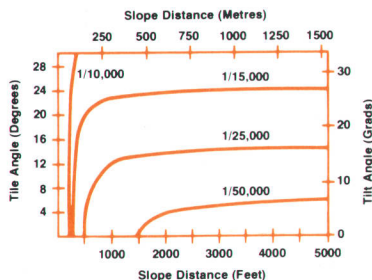

**UNIT OF DISPLAY:** .001 ft or .001m Distance  
 1 sec or 10" Zenith Angle

**DISPLAY RATE:** Track Mode

2 sec/reading - slope distance  
 3 sec/reading - horizontal or vertical distance  
 1/2 sec/reading - zenith angle

**UNIT OF MEASUREMENT:** selectable in either feet or metres and either degrees/minutes/seconds or grads

**TILT RANGE:** -30°

**TELESCOPE:** Internal focus erect image, 18x

**POWER SUPPLY:** optional rechargeable battery pod or external 12 Vdc

**DIMENSIONS:** 13" x 10.3" x 5.8" (330mm x 262mm x 147mm)

**WEIGHT:** Total Station w/o Battery, 26.2 lb (11.9 kg)

    Snap-in Battery Pod, 2.3 lb (1.0 kg)

**Horizontal Angle Base**

**HORIZONTAL ANGLE CIRCLE:** 2.95 inch (75mm) diameter glass circle graduated to 1 degree. Micrometer scale reads direct to 20 seconds or 50" with estimation to 5 seconds or 10"

**OPTICAL MICROMETER READING:** Horizontal angle circle readings are obtained through a reading microscope located on the side of the yoke

**LEVEL VIAL:** plate level vial sensitivity 30 seconds per 2mm

**INTERFACE:** Interfaces to Wild GDF-6 type tribrachs or equal

**EQUIPMENT SUPPLIED:** Pin and hex adjustment wrenches

**BASE OPTIONS:**

OPTION 011: Degree graduation with Wild Interface

OPTION 021: Grad graduation with Wild Interface

NOTE: OPTION 031: 3810A without horizontal angle base

**SERVICE:** One year warranty on material and workmanship. Service contracts available after warranty period.

**PRICE IN U.S.A.:** \$9250

**MANUFACTURING DIVISION:** CIVIL ENGINEERING PRODUCTS DIVISION  
 815 Fourteenth Street, S.W.  
 Loveland, Colorado 80537 U.S.A.

sembly processes and tolerances and by using a high-resolution reticle. The resulting scope, which focuses from three metres to infinity, is repeatable within four seconds of arc.

### Acknowledgments

Many people contributed to the final realization of the HP 3810A Total Station. Appreciation is due these key contributors: Perry Wells for providing the initial angle electronic design as well as fathering the angle transducer development. Ron Klein for development of the limiter/automatic balance functions and environmental test coordination. Dave Smith for development of the angle electronics as well as the power supply and transmitter design and development. Jerry Bybee for his optics mounting, telescope design and development, and mechanical design efforts. Arnold Joslin for his contributions as both in-

dustrial designer and mechanical engineer. Tom Christen, Ken Gilpin, Gary Peterson, and Hal Chase for their efforts in making the angle transducer producible. The members of the 3805 and 3800 distance meter design teams for their invaluable help, especially Dick Clark, Dave Lee, Alfred Gort, Billy Miracle, Claude Mott, and Charles Moore. Wilbur Saul for tooling design on all three projects. Finally, lab manager Bill Smith, for his efforts as instigator and prime mover, whose ideas, energy, and constant search for better answers made the 3810A a reality.

### Reference

1. T.M. Whitney, F. Rodé, and C.C. Tung, "The 'Powerful Pocketful': an Electronic Calculator Challenges the Slide Rule," Hewlett-Packard Journal, June 1972.

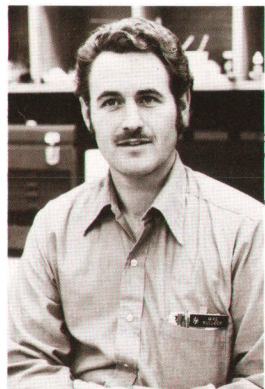

**Michael L. Bullock**

Mike Bullock was engineering group leader for the 3810A Total Station. He was born in Dallas, Texas and attended the University of Texas at Arlington, graduating in 1969 with a BSME degree. Joining HP that same year, he contributed to the mechanical design of the 3800A Distance Meter, then served as mechanical project leader for the 3805A Distance Meter. He's now 3810A production engineer. Mike and his wife and two children live in Berthoud, Colorado and produce most of

their own food by raising animals and a garden. Mike is also interested in solar energy and Bible study, and enjoys golf, hiking and volleyball.



**Richard E. Warren**

Rick Warren received his BSEE degree from the University of Nebraska in 1968 and his MSEE from the University of Southern California in 1970. In 1972, after four years of spacecraft control system design, he joined HP's Civil Engineering Products Division. He developed the processor and software for the 3805A Distance Meter and the phase detector, processor, and software for the 3810A Total Station. He was electrical project leader for the 3810A. Rick is a member of IEEE.

Born in Scottsbluff, Nebraska, he now lives in Loveland, Colorado. He's married and has a 5-year-old daughter. A sports enthusiast, he plays city-league basketball and likes to drive his sports car or go cross-country skiing in the Colorado mountains. He also plays guitar.

# Designing Efficiency into a Digital Processor for an Analytical Instrument

*Hardware control of the I/O system eliminates excessive overhead in the architecture of a digital processor used in a gas chromatograph, leading to significant improvements in operating convenience.*

by John S. Poole and Len Bilen

**T**HE CURRENT RUSH TOWARDS applying microprocessors to all kinds of control tasks has not escaped the notice of those designing analytical instruments for chemical laboratories. In fact, a processor-based gas chromatograph, HP Model 5830A (Fig. 1), was announced two years ago,<sup>1</sup> and an advanced version, Model 5840A (Fig. 2), with 30% more program memory and a magnetic card recorder/reproducer that simplifies the entering of routine set-up instructions and calibration information was recently placed in production. The advantages that built-in digital control gave these instruments has

gained wide acceptance for them by the chemical industry.

## Basic Considerations

How can a digital processor best be utilized in a gas chromatograph? In its simplest form, a gas chromatograph analyzes complex mixtures of organic compounds, separating them into individual molecular compounds by passing a sample in vaporized form through a long, narrow tube that places a "drag" on the chemical components. The drag is a function of the molecular mass and chemical composition of

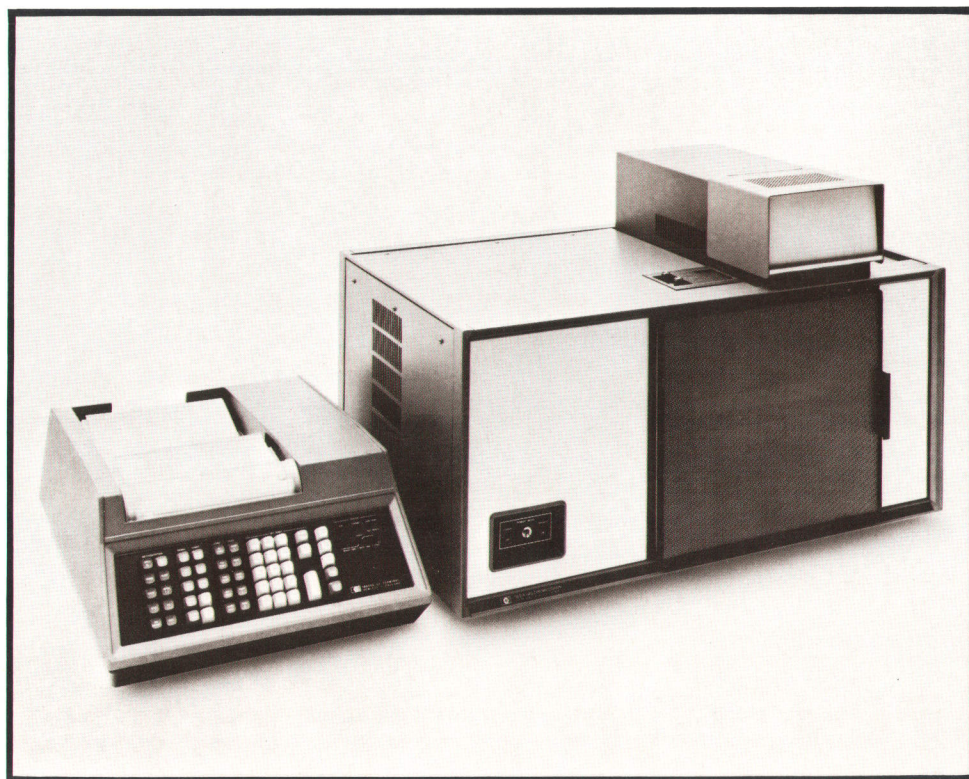

**Fig. 1.** Model 5830A Reporting Gas Chromatograph has a built-in digital processor that operates the instrument throughout an analytical run following instructions entered through the keyboard. It also monitors the detector output, identifying sample components and computing their concentrations, and generates a chromatogram that includes a complete analytical report.

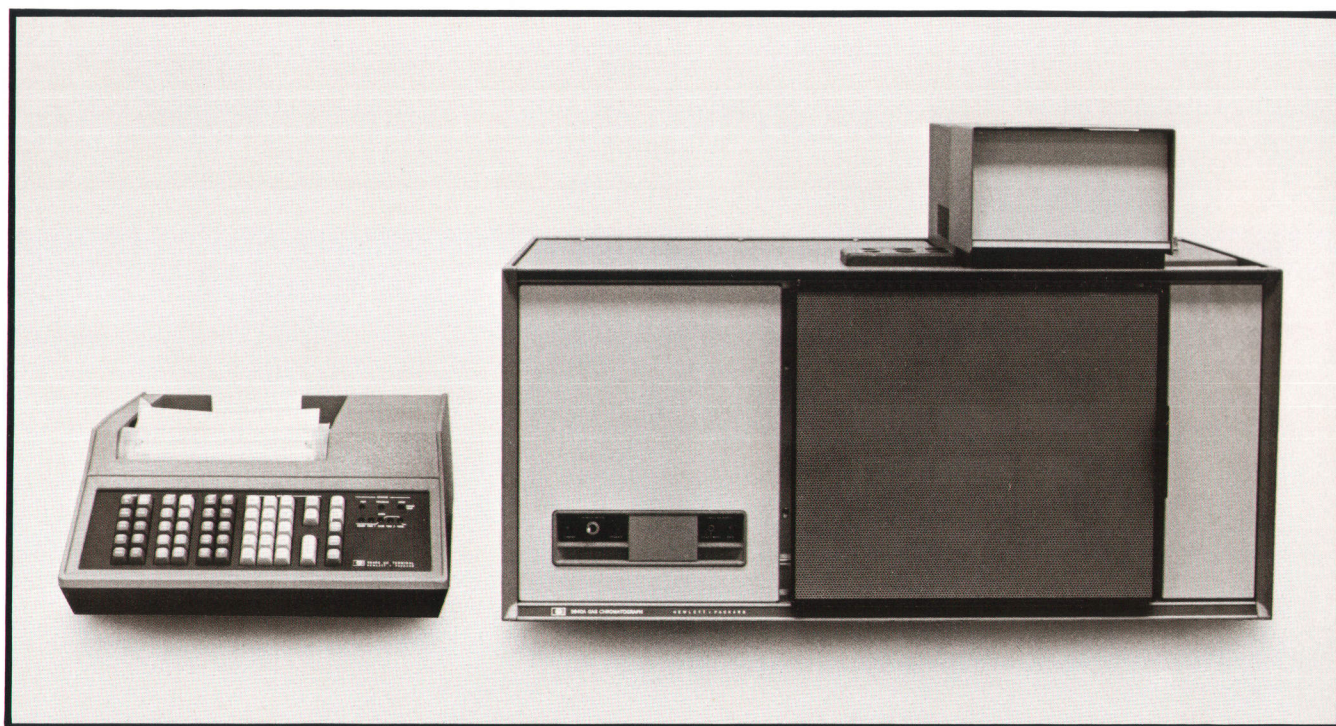

**Fig. 2.** Operating instructions can be entered by way of the keyboard of the new Model 5840A Gas Chromatograph, then edited and recorded on a magnetic strip for later re-entry (Fig. 3). With 30% more memory than Model 5830A, Model 5840A can be programmed to change operating conditions between runs to accommodate sample-to-sample differences.

each component, so the lighter components tend to elute first from the tube, or column as it is commonly known, followed in time by the heavier components.

A detector at the column exit responds to the presence of components as they pass, tracing corresponding peaks on a strip-chart recorder. The result is a chromatogram, as shown in Fig. 4. Each component is identified by the time delay between sample insertion and detector response, called retention time. The area under the curve of each peak is proportional to the amount of that component in the sample.

Measuring the retention times and the areas of the peaks yields the specific results desired. In the past, the level of sophistication used in evaluating this data was the primary limit on the accuracy of analyses. Because manual methods have obvious limitations, the use of electronic data handling devices grew rapidly as the art of chromatography evolved. Initially there were hardware integrators that reported the time and calculated the area of each peak. Then came systems that used analog-to-digital converters to supply the data to computers for application of more sophisticated means of recognizing and evaluating peaks.

Obviously, these computations are tasks suitable for a built-in digital processor. The first such efforts at using built-in digital processors, however, were in stand-alone microprocessor-controlled integrators, such as HP's Model 3380A,<sup>2</sup> that used many of the

computer-based concepts to evaluate peak area.

If used properly, all these methods reduce data analysis errors to negligible levels but they require the use of a relatively expensive auxiliary device with the chromatograph. They also contribute nothing towards improving the primary source of information, the chromatograph itself. Although built-in data an-

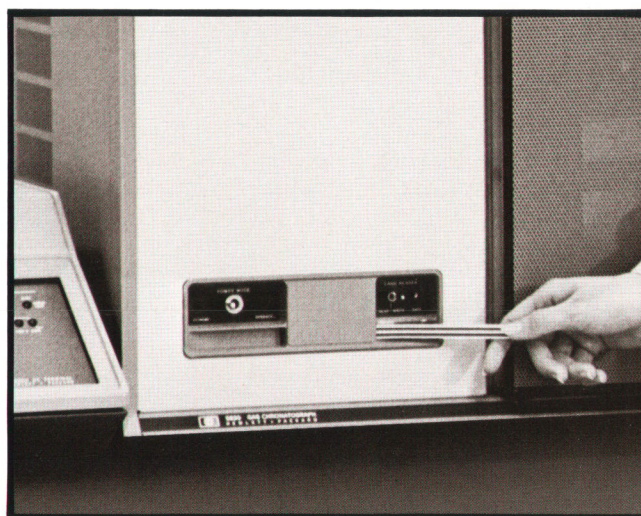

**Fig. 3.** Magnetic cards are long, narrow strips on which set-up instructions and calibration information can be recorded and used to set up the chromatograph at a later time exactly as before.

alysis is the most visible and perhaps most significant difference between the Model 5840A and conventional analog chromatographs, the contribution that the digital processor makes to better chromatograph operation is also of major importance.

To understand this contribution, it is helpful to review the relationship of the processor to the hardware. In a conventional chromatograph, each function and feedback control system has separate electronic circuits and if several detectors are used, each of them also has individual circuits for processing its signal. All of these require individual range or set-point settings. A digital processor, however, is fast enough to handle several signals simultaneously by digital multiplexing so it can service the detector signals while simultaneously carrying out, by means of software algorithms, all the control functions. This automatic control of all aspects of gas chromatograph operation gains a considerable advantage in both cost and performance that alone would justify the use of a digital processor. Since there is sufficient processor time remaining to do data analysis, the analysis turns out to be a bonus obtained essentially free, except for the investment in software development.

The improvement that the digital processor brings to gas chromatograph operation can be illustrated by the autoranging electrometer for the flame ionization detector. With a conventional chromatograph, the operator has to select an electrometer range setting by means of front-panel switches. Selection of a too-sensitive range can result in flat-topped peaks caused by electrometer saturation whereas a not-sensitive-enough range may result in failure to detect trace-concentration components. With autoranging under processor control, the detector is always operated on an appropriate range so very low trace concentrations can be analyzed during the very same run as major components.

#### Designed-in Digital Control

The goal sought in the design of the digitally-controlled gas chromatographs was to provide automatic data reduction and printout of the results along with elimination of as many operator errors as possible by the use of autoranging detectors and automatic selection of integrating parameters. Also, the digital processor could schedule oven temperature changes, switch the column effluent to other detectors, and do many of the other chores that had kept a chemist tied to his chromatograph during lengthy procedures, some of which can go on for hours.

The most economical way to integrate all these functions into a single instrument that met our performance standards was to use a central processing unit (CPU) with computer-like architecture. The heart of the system that evolved is a 16-bit, serial-oriented

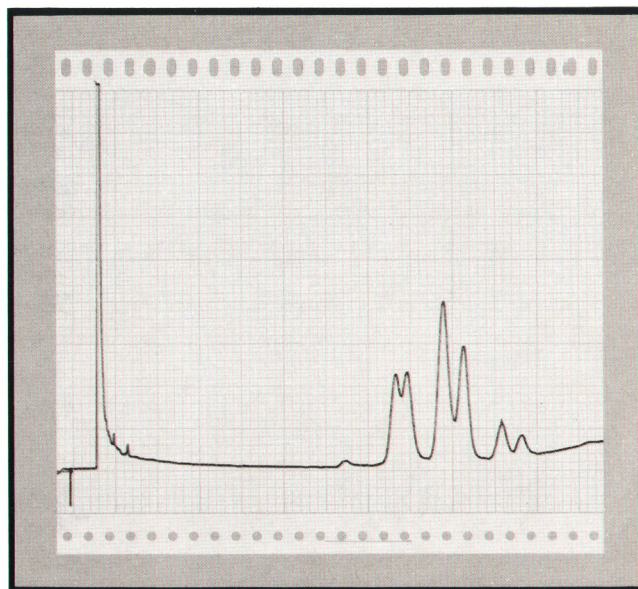

**Fig. 4.** Relatively simple chromatogram made by a manually operated gas chromatograph. To analyze results, the chemist must derive the time delay between sample insertion (marked by the negative spike at left) and each peak, and the area bounded by each peak and the baseline. Special calculations determine areas of peaks that overlap, like those shown here. Chromatograms of complex mixtures such as crude oil may be 10 times as long and have hundreds of peaks.

CPU like that used in the HP 9800-series Calculators.<sup>3</sup> Besides the 16-bit word size, a clock rate of around 5 MHz was needed to perform all the desired operations in a reasonable length of time, requirements that could not be met by the microprocessors available at the time. Hence, MSI computer circuits were used.

All operating parameters are entered through the function-oriented keyboard (Fig. 5), eliminating the many control knobs that a sophisticated gas chromatograph can have. The parameters are stored in a read/write memory as digital numbers, allowing the operating values to be entered with much greater resolution than is economically possible with the rotary, slide, or pushbutton switches commonly used. By pressing the LIST key, all variables under processor control relating to the chemical analysis are recorded automatically on the chromatogram, giving all the data pertinent to the analysis on a single sheet of paper.

#### Organizing the Processor

Processor organization is shown in Fig. 6. Each system parameter that operates under processor control is treated as a peripheral to the CPU, and is accessed through the I/O bus. For example, each heated zone has a unique electrical address, and temperature control is executed by a particular algorithm stored in a read-only memory (ROM). Besides economy, this technique provides several advantages over previous



**Fig. 5.** Through the keyboard, all aspects of the analysis are controlled—the column oven temperature program, the temperatures of other heated zones, the integration parameters, the calibration, and the type of computation. Operation of backflush valves, a change in recorder speed, a change in detectors, and other parameters can be programmed to occur at specific times following the start of a run.

methods of hardware control, such as enabling the listing of setpoint and the actual value of any heated zone as an integral part of the final printout of results.

The key to efficient utilization of the processor system was recognition of the fact that the peripherals connected to the I/O bus need constant attention and therefore should not be accessed by the usual I/O routines, that is with a request for interrupt followed by a CPU poll and so on. It was decided to establish a regular, periodic interrupt routine controlled by

hardware. This allows each device to be serviced on a known schedule so module operation can be synchronized to have data ready when serviced.

This scheme is implemented by using three of the bus lines for hardware-controlled addresses. Addresses are placed on these lines by square-wave divider circuits such that a 40-Hz square wave appears on the first line, a 20-Hz square wave on the second, and a 10-Hz square wave on the third, as shown in Fig. 6. Each time a transition of the 40-Hz square wave

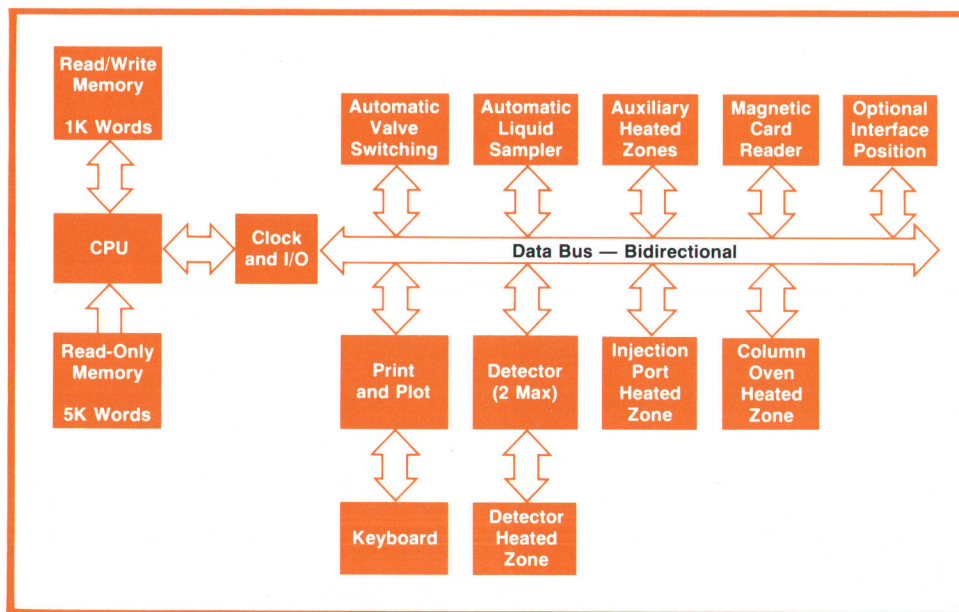

**Fig. 6.** Organization of the digital processor in the Model 5830A Gas Chromatograph.



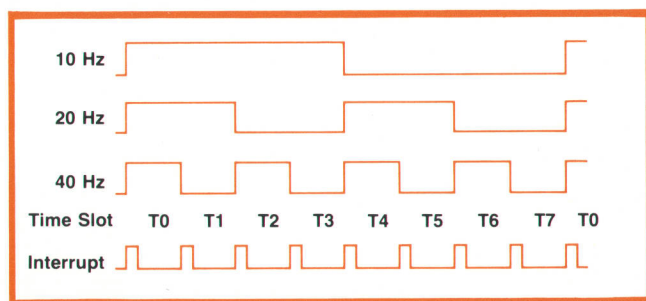

**Fig. 7.** An interrupt occurs on each transition of the 40-Hz square wave. The states of the square waves at each interrupt define a 3-bit address for the routines to be performed during that interrupt.

occurs, an interrupt is generated and the present states of the three lines determine the I/O address for that interrupt. This is the only interrupt in the system, and it occurs 80 times a second. All eight addresses are thus cycled ten times a second.

A software counter in the CPU, synchronized to the hardware system, addresses a section of ROM for determining the servicing routine for each interrupt slot. The ROM programs cause the processor to address four other lines on the data bus called qualifier lines. One of these determines the direction of data flow and the other three address various functions. During any one interrupt time slot, up to eight functions may be addressed sequentially by the qualifier lines. Consequently, with these seven lines the processor has the capability of addressing up to 64 locations 10 times a second, and to determine the direction of data flow at each location.

### Address Organization

The address locations are listed in the table below. Note that the printer/plotter is addressed during every interrupt. This enables the printer/plotter to access data 80 times a second for simultaneous real-time

Qualifier Address	Time Slot Address							
	0	1	2	3	4	5	6	7
0	Chan A Aux Det Signal				Chan B Aux Det Signal	Keyboard		
1	Chan A FID Signal			Cryo Valve		Aux Contact Closures		
2	TCD Signal			Door Valve		Liquid Sampler Control		
3	Data Communications Option							
4	Aux Heated Zone	Inj. Port Heated Zone	TCD Heated Zone	Oven Temp Control	FID Heated Zone	Col A Flow	Col B Flow	
5	Magnetic Card Reader							
6	Reserved for Options							
7	Interrupt Control and Test							

Time Slot and Qualifier Address Function Table

plotting and/or printing.

A brief description of the addresses will aid in understanding how the processor is used. Addresses 00, 01, 02, 40, and 41 are 32-bit transfers of data from the detectors to the processor. The instrument handles up to five detector data signals on the bus. Specific addresses are allocated for the detectors commonly used in GC work, i.e. the flame-ionization detector (FID) and the thermal conductivity detector (TCD), and a third address is allocated on each of the chromatograph's two channels for any special detectors that the chromatographer may wish to use.

Addresses 04, 14, 24, 34, and 44 are concerned with temperature control in various parts of the chromatograph. The read/write qualifier is used in conjunction with these addresses to enable data transfer in either direction. First, a digital word describing the actual temperature of the particular zone is transferred from detectors in the heated zone to the processor. An algorithm stored in ROM compares the actual temperature to the setpoint previously entered in the read/write memory from the keyboard. The algorithm then calculates a duty cycle for the triac supplying power to the zone heater and transfers the value of the duty cycle to the zone controller. Note that the temperatures of all these zones are sampled and corrected 10 times a second.

Addresses 31 and 32 are concerned with column oven temperature. A combination of resistance heating, cryogenic cooling, and ambient air mixing is used, permitting the setpoint for the oven temperature to be set anywhere between  $-50^{\circ}\text{C}$  and  $+400^{\circ}\text{C}$ .

Address 50 is for the keyboard. When any key is pressed, its identity is stored in a register. Address 50 transfers the contents of this register to the CPU for interpretation.

Address 51 is for control of external devices such as valves for sample injection or column switching. Because the processor has a master clock, a list of time-dependent variables such as these valves may be stored in a software table and executed as a function of time elapsed since sample injection. Keyboard entries define the function that is to occur and the time of occurrence. Time programming is available for time-dependent variables within the instrument as well as for the external devices.

Address 52 is for an automatic liquid sampler (HP Model 7671A). The actual injection sequence for the mechanism is stored in a programmable read-only memory in the chromatograph. The sequence can be actuated by the CPU during address 52 or information concerning the status of the sequence can be transferred to the CPU.

Addresses 54 and 64 are for transmitting digital readings from the electronic flow sensors in columns A and B. Address 60 is reserved for future options.

Time slot 7 is used by the CPU for synchronizing the hardware/software system.

When the processor completes its housekeeping functions in each interrupt time slot, it returns to the background program until the next interrupt occurs. Everything described so far requires only about 30% of the processor time, leaving plenty of time for background programs such as the integrating algorithms and calculations.

### Printing with a Plotter

The operation of the printer-plotter is another example of the contribution that digital control can make. The recording "stylus" is a small ceramic rectangle on which a single vertical row of seven dots is formed by thick-film techniques. Each dot is a resistor that reaches a temperature of 200°C in about 4 ms when 100 mA at 20 V is applied. Power is maintained for about 6 ms, enough time for the heat to change the color of the heat-sensitive paper where touched by the dot.

The dots are selectively pulsed by the CPU as the column of dots is moved linearly across the page. This generates characters with the equivalent of a 5×7 dot matrix.

To trace the chromatogram, one of the dots is turned on continuously at reduced power. The detector output, which is converted to digital words 10 times a second for transmission to the CPU, is reconverted to an analog voltage for driving the servo mechanism that positions the print head. To achieve high resolution, a constant-density trace is maintained by modulating the power to the print head as a function of stylus slew rate. The CPU calculates the slew rate 80 times a second and a digital word describing the required power level is transmitted to the printer-plotter module.

At the same time, the CPU controls the stepping motor that drives the recorder chart. Either a step or a no-step pulse is transmitted to the motor during each interrupt. The chart speed is thus determined by the rate at which step pulses occur, which is calculated by the CPU according to the chart speed entered on the keyboard. This technique permits the chart speed to be set from 0 to 10 cm/min in 0.01-cm/min increments. As with the zone temperature controllers, this fine resolution is obtained with no increase in hardware costs.

The ability to intermix printing and real-time plotting without causing discontinuities in the plot is another advantage derived from driving the chart under CPU control. When a retention time is to be written adjacent to a peak, the chart drive is stopped and subsequent realtime data points stored while the printed information is being generated. Plotting resumes when the printing operation is complete, but it

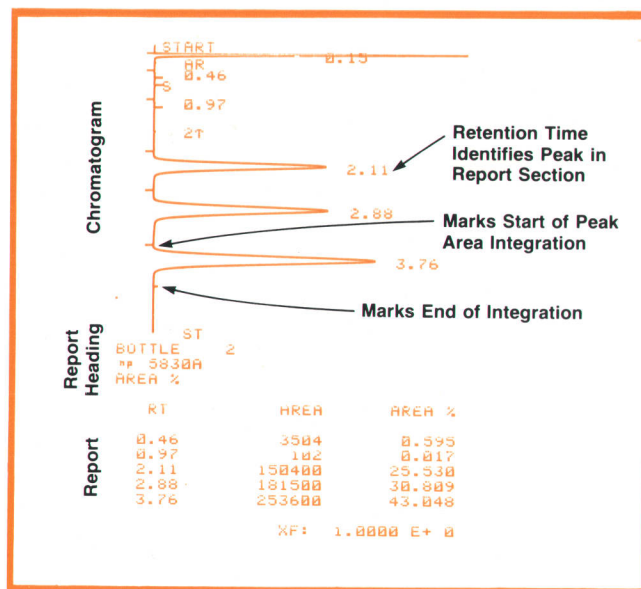

Fig. 8. The printer-plotter traces a chromatogram as an analysis proceeds and prints pertinent data on the same sheet of paper. In this example, calculations determine the percentage of each peak with respect to the total area of all peaks. The basic data is retained in memory so the operator can call for additional reports calculated in other ways.

goes at an increased rate until the stored data points are all plotted. The chart speed then returns to normal and real-time plotting resumes.

With its ability to both print and plot, the printer-plotter greatly simplifies record keeping by enabling the chromatogram, operating parameters, and the calculated results to all be recorded on the same piece of paper, as shown in Fig. 8.

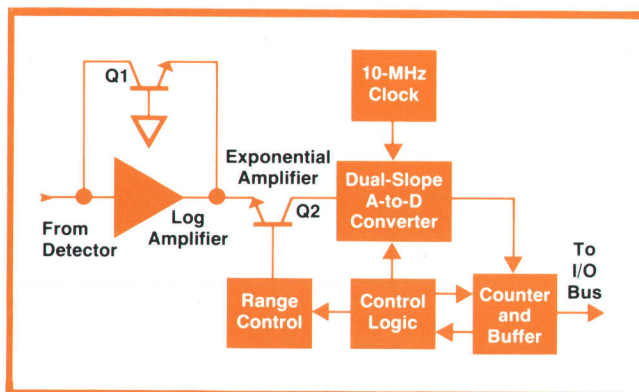

Fig. 9. The electrometer for the FID uses the exponential relationship between the emitter-base voltage and collector current of a transistor. In the feedback path of the input amplifier, it derives a logarithmic relationship between input and output (Q1). In the next stage (Q2), it linearizes the amplifier output. Ranging is accomplished by changing the base voltage, and hence the amplification factor, of transistor Q2.

### Invisible Autoranging

With the digital processor integrated into the gas chromatograph, it was possible to incorporate autoranging into the detectors in a way that made the operation invisible to the user.

The electrometer used with the flame ionization detector (FID) is based on the electrometer developed for the HP Model 5700A Gas Chromatograph.<sup>4</sup> This electrometer eliminated many of the problems of earlier designs by using a logarithmic amplifier that can accommodate input signals over a wide dynamic range followed by an exponential amplifier that linearizes the output of the logarithmic amplifier (Fig. 9). Range switching occurs at a low-impedance point where it can be executed without introducing the kind of transients that occur when the high-impedance circuits of a conventional electrometer are switched.

The digital-to-analog converter that follows the exponential amplifier is a conventional dual-slope converter as found in many digital multimeters. The clock rate for the converter is 10 MHz, enabling a complete, high-resolution conversion in less than 1 ms. For each reading, 100 conversions are added, thereby giving an averaged value that has improved signal-to-noise ratio.

Ranges are switched by comparators that look at the output of the analog-to-digital converter, upranging if the accumulating clock pulses reach a full count before the measurement cycle is complete, or downranging if the count does not reach 20% of maximum by the end of the measurement cycle. Since a range change occurs within 1 ms of the start of a measurement cycle, the system is able to track peaks that have very fast leading edges.

The range-to-range ratio was made 16 to 1 so a range change can be introduced into the binary output simply by shifting it four places. Thus the CPU always sees a number corresponding to the absolute value of the electrometer output over a wide dynamic range without recourse to a separate range indication. The only range change visible to the user is the user's own selection of a suitable recorder sensitivity.

Similar arrangements for digital readout and autoranging are used with the other types of detectors. A major benefit of autoranging is the elimination of errors resulting from undetected overranging. Some detector systems do not clip a peak overload but round the top of the peak, giving it the appearance of a normal peak. It thus happens that the detector amplifier can be operated in a non-linear region, causing errors in the interpretation of the chromatogram, without the user's being aware that an overrange condition exists. This does not happen with the digitally-controlled chromatograph.

### Safe Unattended Operation

Because the use of the digital processor with its stored programs made long periods of unattended operation possible, the design of the entire gas chromatograph had to be made fail-safe with consideration given to many areas unrelated to chemical performance. For example, the memory is protected against loss of its contents by a standby battery power supply that can support the memory for the duration of a typical power failure. In the event that the power is off longer than the standby power supply can support the memory, the system automatically enters default values when power returns so no harm is caused the system on restart.

The power supplies are protected against both overvoltage and overcurrent such that an orderly shutdown occurs before any part of the instrument is damaged. The heated zones are protected by an independent software-controlled detection circuit that shuts down secondary 115V power to the zones and the column oven before damage can occur.

The concern for fail-safe operation also extended to non-electronic parts of the system. For example, hydrogen gas, sometimes used as a carrier gas and commonly used in the FIDs, could fill the column oven and be ignited by the resistance heaters if there were a leak. If this should occur, the resulting violent explosion must be contained within the shell of the instrument to prevent injury to nearby personnel. This places quite a burden on the designer because it is also desirable to keep the mass of the oven low to give fast thermal response. The design of the oven in the Models 5830A/5840A is such that it successfully withstands multiple test explosions.

### Acknowledgments

Doug Smith and Ivan Crockett generated the original concept of a processor-based gas chromatograph and developed the architecture of the instrument. Ruder Schill was responsible for the man/machine interface, defining the keyboard, data handling methodology, and final report format. 

### References

1. G.V. Peterson and J.S. Poole, "Design Concepts of a Processor-Based Gas Chromatograph," American Laboratory, May 1974.
2. A. Stefanski, "Deriving and Reporting Chromatograph Data with a Microprocessor-Controlled Integrator," Hewlett-Packard Journal, December 1974.
3. H.J. Kohoutek, "9800 Processor Incorporates 8-MHz Microprocessor," Hewlett-Packard Journal, December 1972.
4. D.H. Smith, "High Performance Flame-Ionization Detector Systems for Gas Chromatography," Hewlett-Packard Journal, March 1973.



### Len Bilen

Born in Sysekil, Sweden, Len Bilen graduated from the Chalmers University of Technology, Sweden, in 1965 with a degree in physics. Prior to joining HP, he spent three years at Saab, where he was involved with the central processor of the Viggen aircraft, and a year and a half at General Dynamics in Rochester, New York, with responsibility for processor-controlled test stations on the F111B aircraft. At HP he had major software responsibility for the

5830A Gas Chromatograph and was project leader for the 5840A. He is married and has three children. Church activities and maintaining a house claim most of Len's spare time.



### John S. Poole

Before joining HP in 1967, John Poole worked for six years on satellite instrumentation at the U.S. Naval Research Labs in Washington, D.C., where he was involved in the design, launch, tracking, and data reduction aspects of spacecraft operation. He has a BSEE degree from the University of Delaware and has completed work towards an MSEE degree there. At HP, he was project leader on the 7670A Automatic Sampler and was manu-

facturing engineering manager for a year and a half before assuming project leadership of the 5830A Gas Chromatograph. Married, and with three children, his activities include boating, water skiing, and swimming.

## SPECIFICATIONS HP Model 5840A Gas Chromatograph

**BASIC INSTRUMENT SPECIFICATION:** Processor-based, keyboard-controlled, one or two detector(s), single- or multiple-column gas chromatograph with integration, time-programmable functions, carrier flow rate printout, temperature programming, and Area% and methods calculations.

**THERMAL-WRITING PRINTER/PLOTTER OUTPUTS:** chromatogram with retention times printed near the peak apex, listing of any or all function set-points with actual temperatures; quantitative analytical results.

**CARRIER GAS FLOW:** Controlled by differential controller(s) mounted in insulated container that may be optionally thermostated. Dual-channel flow sensor is standard, with switch selection for type of gas flowing in each channel (hydrogen, helium, nitrogen, argon/methane). Flow rate in each channel is printed at keyboard command. Sensor range is 0 to 100 ml/min in 0.1 ml increments for all four gases.

**INJECTORS:** Standard injection port is heated interchangeable liner type with on-column injection capability by extending column inside injector, in place of liner. Injector can be readily moved to any of three positions permitting use of 6, 7 $\frac{1}{2}$ , or 9" coil diameter columns.

#### COLUMN OVEN:

**CAPACITY:** Usable volume for column installation 11 in W x 11 in H x 4 in D accepts 1/16 - 1/8 - 1/4 in OD metal or glass columns with 6 or 7 $\frac{1}{2}$  or 9 in diameter coils (See injectors).

**TEMPERATURE CONTROL RANGE:** in 1°C increments from 35° (or 5° above ambient, whichever is greater) to 400°C; from -65° with cryogenic option.

**LINEAR PROGRAMMING RANGE:** From 0.01 to 30°C/min in 0.01 increments. Multi-linear rates available by timetable command.

**PROGRAMMING TIMERS:** Initial and final times to 327 mins in 0.01 min increments.

**ZONE OVERHEAT PROTECTION:** From 0 to 400°C in 1°C increments.

**HEATED ZONES:** Setpoint range from 0° to 400°C in 1°C increments for injectors, flame and thermal conductivity detectors and auxiliary circuit.

**FLAME DETECTOR:** Single or dual configuration—dual flame unit can be operated in compensation mode or single mode. Integral on/off control for each air and

hydrogen flow, fixed restrictor in each line with pressure vs flow rate calibration supplied; make-up gas kit accessory for low carrier flow applications; accessory for pressure regulation/readout on front panel for (both) hydrogen flow(s). Digital electrometer automatically ranges through five hexadecimal range of detector signal.

**TC DETECTOR:** Dual-passivated filament design, each in a cartridge, with filament overheat protection circuit. Sensitivity selected by four-position switch with filament current automatically set as a function of detector temperature.

**VALVES/CONTACT CLOSURES:** Up to four automated or manual valves (ambient or heated) may be installed in valve compartment. Automatic valves are controlled from keyboard. Four contact closures are available to operate or to signal external devices.

**TIMETABLE:** Function changes during a run by timetable command, for the following:

Detector selection	Slope sensitivity	Chart speed
Area rejection	Baseline zero	Attenuation
Valve switching	Rate °C/min	Integrator functions
	Hold temp	

The run stop time may also be time programmed.

**INTEGRATION:** Eleven controls, all of which may be changed by timetable command.

**SLOPE SENSITIVITY:** Values from 0.01 to 81 or a value of zero for noise-based automatic slope sensitivity selection (updated during run); tangent skim integration is automatic on tail of peak defined as solvent, and can be set manually at any time or by timetable command.

**AREA REJECTION:** Values from 1 to 9998000000.

**PEAK CAPACITY:** 250 x (1 - XRW) - (3/2)(time table entries) - (3/2)(change run entries) - (5/2)(#calibrated peaks)

#### METHODS:

TYPE: Internal standard - normalization - external standard in addition to an Area% calculation

**CALIBRATION:** One calibration is stored and is common to all method calculations. Dialog for method calibration is independent of method type; special key for entry of amount of internal standard added to sample, and sample amount. Recalibration possible.

**PEAK IDENTIFICATION:** Calibrated peaks other than reference peak are automatically identified by relative retention. In ESTD and NORM methods, identification by absolute retention time occurs automatically if reference peak is not found. Analyst may deliberately select this alternate type of identification for all calibrated peaks in ESTD and NORM methods.

#### PRINTER/PLOTTER:

**CHART SPEEDS:** From 0 to 10 cm/min in 0.01 increments, chart driver start/stop can be manual or automatic.

**PAPER:** Thermal-writing z-fold perforated and numbered for 200 sheets 8 $\frac{1}{2}$  x 11 in.

**AUTOMATIC LIQUID INJECTION:** Automated analysis of up to 35 samples available in special keyboard controlled version of Model 7671.

#### PHYSICAL:

**TEMPERATURE:** Unless otherwise specified Model 5840A with checkout column(s) installed is guaranteed to perform within stated specifications over ambient range of 15-45°C, 0-90% relative humidity range.

**SIZE:** Oven module 21 $\frac{1}{2}$ H x 21 $\frac{1}{2}$ D x 34 in W (54.6 x 54.6 x 86.4 cm); terminal 8H x 22 $\frac{1}{2}$ D x 17 $\frac{1}{2}$  in W (20.3 x 57.2 x 44.5 cm).

**WEIGHT:** 160 lbs (73 kg)

**POWER:** 120V (+5, -10%) 58/62 Hz, 220V (+5, -10%) 48/62 Hz single or split phase, 240V (+5, -10%) 48/62 Hz single or split phase.

**PRICE IN U.S.A.:** Begins at \$11,525 for a complete system.

**MANUFACTURING DIVISION:** AVONDALE DIVISION  
Route 41 & Starr Road  
Avondale, Pennsylvania 19311 U.S.A.

\*Option read/write memory = 1 if installed, otherwise = 0.

Hewlett-Packard Company, 1501 Page Mill Road, Palo Alto, California 94304

## HEWLETT-PACKARD JOURNAL

APRIL 1976 Volume 27 • Number 8

Technical Information from the Laboratories of  
Hewlett-Packard Company

Hewlett-Packard S.A., CH-1217 Meyrin 2  
Geneva, Switzerland  
Yokogawa-Hewlett-Packard Ltd., Shibuya-Ku  
Tokyo 151 Japan

Editorial Director • Howard L. Roberts  
Managing Editor • Richard P. Dolan  
Art Director, Photographer • Arvid A. Danielson  
Illustrator • Sue M. Perez  
Administrative Services, Typography • Anne S. LoPresti  
European Production Manager • Michel Foglia

Bulk Rate  
U.S. Postage  
Paid  
Hewlett-Packard  
Company

**CHANGE OF ADDRESS:** To change your address or delete your name from our mailing list please send us your old address label (it peels off). Send changes to Hewlett-Packard Journal, 1501 Page Mill Road, Palo Alto, California 94304 U.S.A. Allow 60 days.